

**NARVA**  
DAS LICHT



**ILUMINAT PENTRU  
INDUSTRIA AUTO**

---

Catalog 2023

# CUPRINS

## LED

### 12/24V VEHICULE ȘI CAMIOANE



<b>DE CARE TIP DE UPGRADE DE LED AVEȚI NEVOIE?</b>	10	<b>SEMNALIZARE ȘI ILUMINAT INTERIOR</b> Range Performance LED	14
<b>LĂMPI PENTRU FARURI</b> Range Performance LED	12		

## CONVENȚIONALE

### 12V VEHICULE



<b>DE CARE TIP DE LAMPĂ DE 12V AVEȚI NEVOIE?</b>	20	<b>SEMNALIZARE ȘI ILUMINAT INTERIOR</b>	
<b>LĂMPI PENTRU FARURI</b>		Semnalizare	32
Standard	23	Lămpi miniaturale cu halogen	34
Long Life	25	Lămpi indicatoare cu bază tip pană	34
Range Power 50+	26	Lămpi Festoon	35
Range Power 150	26	Lămpi cu bază din plastic (Bax)	36
Range Power Blue+	27	Range Power Blue+	38
Range Power White	28	<b>SETURI DE REZERVĂ</b>	40
Rallye	29	<b>INSTRUMENTE DE VÂNZĂRI</b>	41
Tipuri americane	30		

### 24V CAMIOANE



<b>DE CE TIP DE LAMPĂ DE 24V AVEȚI NEVOIE?</b>	43	Lămpi miniaturale cu halogen	47
<b>LĂMPI PENTRU FARURI</b>		Lămpi indicatoare cu bază tip pană	48
Standard	44	Lămpi Festoon	48
Heavy Duty	45	Lămpi cu bază din plastic (Bax)	49
Rallye	45	Heavy Duty	50
<b>SEMNALIZARE ȘI ILUMINAT INTERIOR</b>		<b>SETURI DE REZERVĂ</b>	51
Semnalizare	46	<b>INSTRUMENTE DE VÂNZĂRI</b>	51

### 12V VEHICULE PE DOUĂ ROȚI



<b>DE CARE DINTRE TIPURILE DE LĂMPI PENTRU VEHICULE PE DOUĂ ROȚI AVEȚI NEVOIE?</b>	53	<b>LĂMPI PENTRU FARURI</b> Standard	54
--	----	--	----

## XENON

### VEHICULE ȘI CAMIOANE



<b>DE CE TIP DE LAMPĂ AVEȚI NEVOIE?</b>	59	<b>LĂMPI PENTRU FARURI</b> Standard	61
---	----	--	----

<b>ILUSTRĂȚII TEHNICE</b>	62
<b>BAZE (IEC 60061-1)</b>	64
<b>AMBALAJ</b>	66

# EXPERȚI ÎN ILUMINAT PENTRU INDUSTRIA AUTO



Pentru mai multe informații despre NARVA, vizitați site-ul nostru  
[WWW.NARVA-LIGHT.COM](http://WWW.NARVA-LIGHT.COM)

## CLIEȚII NOȘTRI SUNT PE PRIMUL LOC

**Pentru NARVA, satisfacția clienților este prioritatea numărul unu.**

NARVA oferă produse de iluminare de înaltă calitate pentru automobile, astfel încât profesioniștii să poată satisface toate nevoile clienților. Cu NARVA, garajele și atelierelor pot oferi produse și servicii durabile și de calitate, la un preț accesibil. NARVA a dezvoltat un portofoliu de produse cuprinzător pentru a satisface nevoile profesioniștilor din întreaga lume. Echipele și distribuitorii NARVA sunt dedicați servicii și informării clienților noștri din întreaga lume.

Depunem eforturi susținute pentru a satisface în mod eficient toate solicitările clienților și ale pieței din toate domeniile noastre de activitate. Birourile noastre de vânzări, împreună

cu un depozit central, acordă atenție specială asistenței pentru clienți și un serviciu de livrare eficient. Echipele și distribuitorii NARVA sunt dedicați asigurării de servicii de calitate extraordinară pentru clienții noștri din toate zonele de activitate.

Grija față de clienți începe cu un produs de calitate la un preț accesibil. Pe măsură ce drumurile de astăzi devin din ce în ce mai congestionate, credem că toți șoferii trebuie să își poată permite o soluție de iluminare de calitate și fiabilă pentru a beneficia de siguranță și vizibilitate crescute.

**ILUMINARE DE CALITATE LA UN PREȚ ACCESIBIL,  
DISPONIBILĂ ACUM PENTRU TOATĂ LUMEA.**

## CALITATEA NOASTRĂ LA UN PREȚ ACCESIBIL

- / NARVA, peste 70 de ani de experiență în iluminat pentru industria auto.
- / Teste cuprinzătoare pe durata întregului proces de producție
- / Control permanent al calității fiecărei lampi
- / Teste de conformitate și procese de certificare internațională, inclusiv IATF 16949, DIN EN ISO 14001, CEE R37, CEE R99
- / Investiții permanente în inovații ale produselor și în procese noi.

Calitatea produselor și proceselor de producție NARVA este controlată în mod regulat. Produsele noastre respectă reglementările CEE\* și alte cerințe legale. (Consultați soluțiile de iluminat de care aveți nevoie la pagina 2 pentru a descoperi toate produsele de iluminare omologate CEE.) Procesele de producție NARVA, precum și cele de marketing și logistică, sunt controlate regulat cu ajutorul standardelor tehnologice IATF. CEE a creat îndrumări internaționale pentru industria auto

și pentru furnizorii săi, cu scopul de a reduce barierele comerciale și de a spori siguranța traficului. Produsele ce nu respectă reglementările CEE nu pot fi vândute în Europa. Produsele Narva respectă regulamentul nr. 37 al CEE privind lămpile cu incandescență și regulamentul nr. 99 privind lămpile cu descărcare în gaz, care oferă linii directe, inclusiv măsurători, flux luminos și capacitate. ISO/ TS 16949 este dovada unei integrări puternice a siguranței și stabilității în procesele de producție, marketing și logistică. Cei peste 70 de ani de experiență și know-how definesc toate soluțiile de iluminat NARVA. NARVA efectuează în permanență teste asupra produselor de iluminat pentru industria auto pentru a îmbunătăți și asigura o calitate constantă.

\*CEE = Comisia Economică Europeană



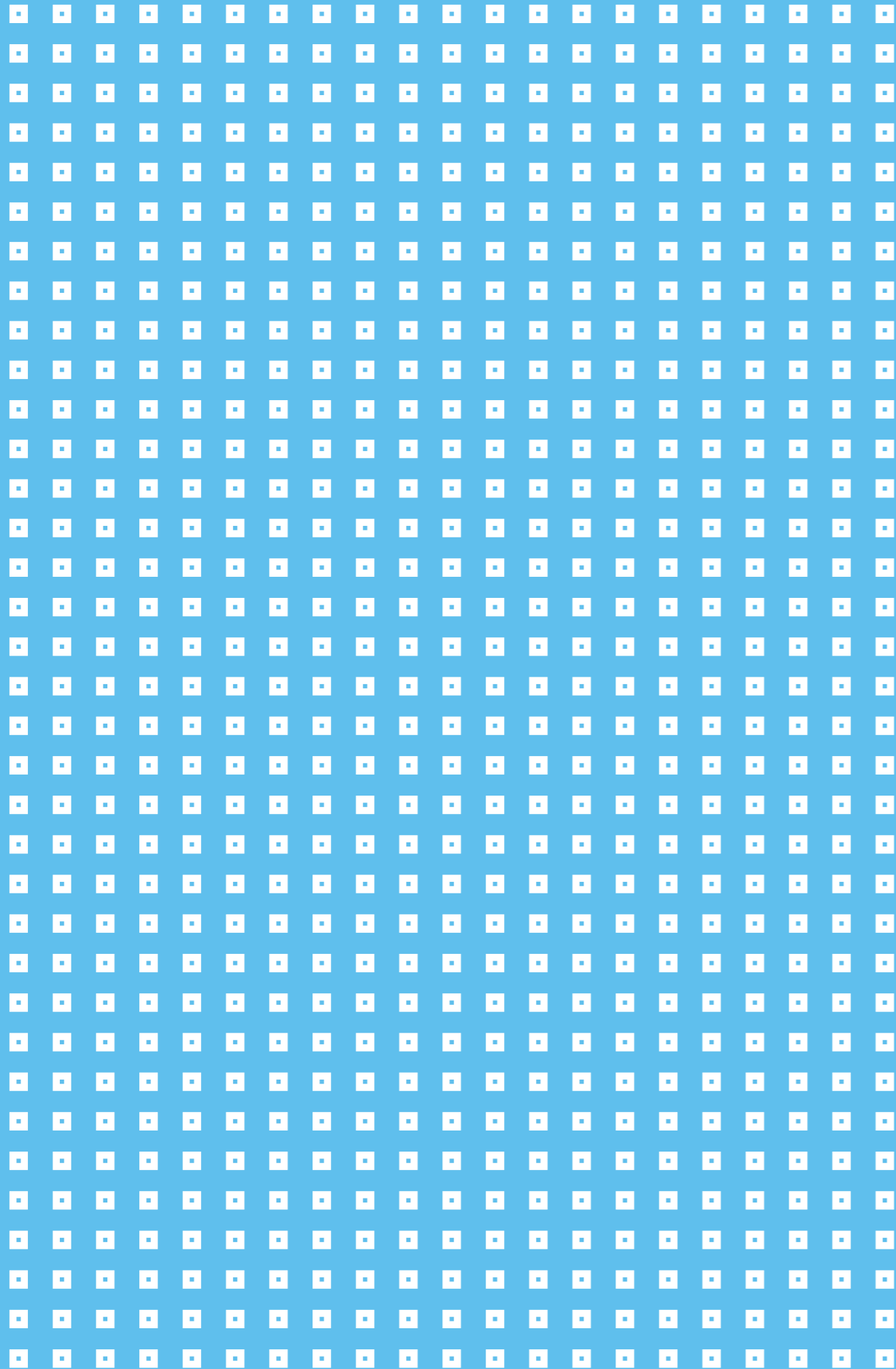

# SOLUȚII LED

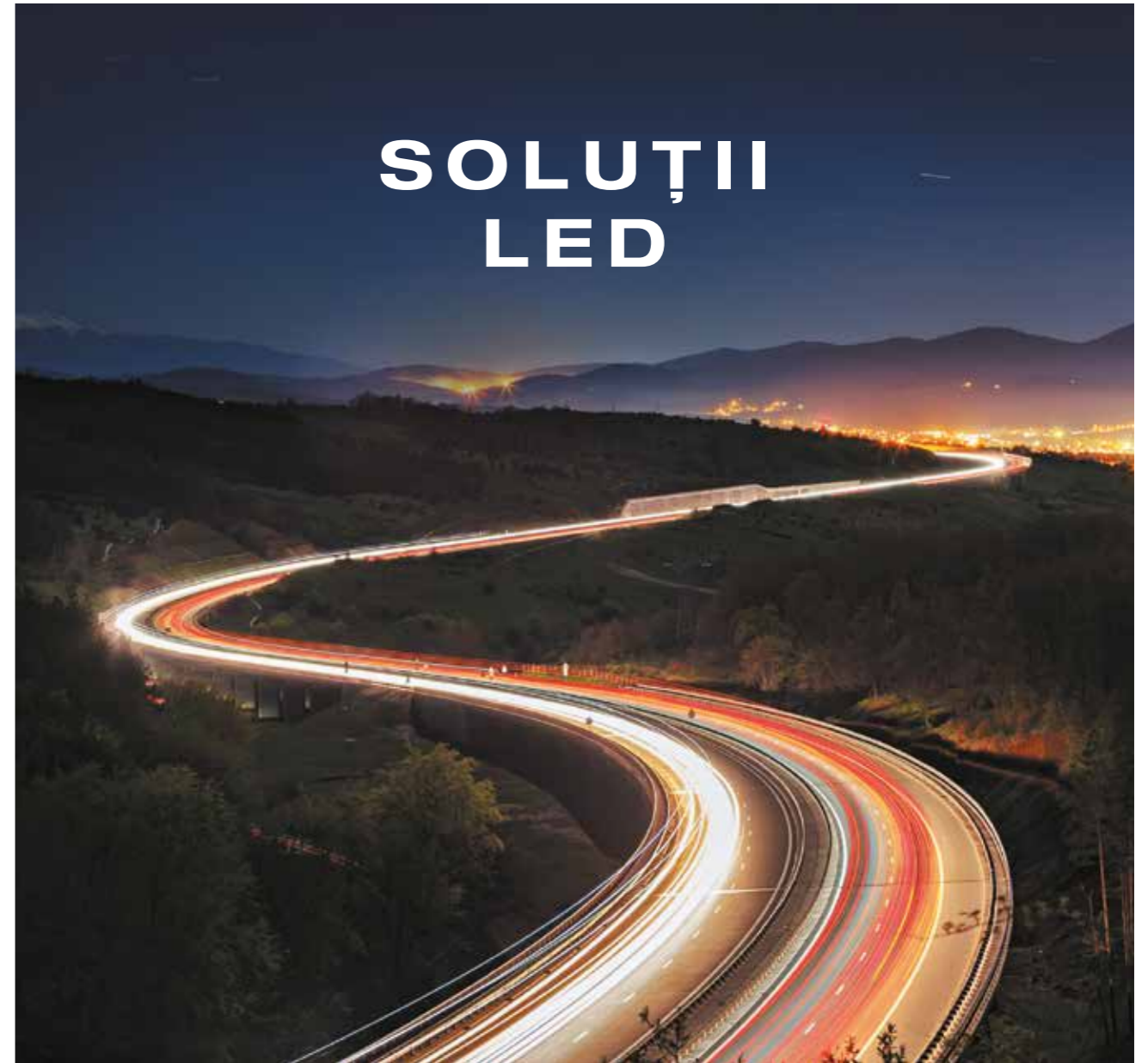

## RANGE PERFORMANCE LED



- HL [≈H1]
- HL [≈H3]
- HL [≈H4]
- HL [≈H7]
- HL [≈H11]
- FL [≈H8/H11/H16]
- HL [≈HB3/HB4]
- HL [≈HIR2]

Este responsabilitatea dvs. să vă asigurați că utilizarea luminilor cu LED cu montare pe vechile instalații respectă cerințele legale aplicabile.





# LED

## LĂMPI DE 12/24V



Transformați mașina dvs. dintr-una standard în una elegantă cu o singură mișcare ușoară cu minunatele becuri noi cu LED **NARVA Range Performance**.

Cu lumină clară, albă și culori excelente, nu numai că veți arăta bine, dar veți vedea și mai mult și veți reacționa mai rapid.

## RANGE PERFORMANCE

Iluminați drumul cu faruri albe luminoase, asigurând o vizibilitate mai mare și un aspect uimitor. Datorită dimensiunii lor compacte și designului „răsuciți și fixați”, aceste becuri sunt unele dintre cele mai ușor de instalat.

Cu rezistență termică superioară, farurile sunt protejate de defectele cauzate de căldură, devenind extraordinar de durabile. Designul optic avansat asigură un condus în siguranță fără a orbi participanții la trafic din sens opus.



Halogen standard



Range Performance LED

## INSTALAREA BECURILOR PENTRU FARURI

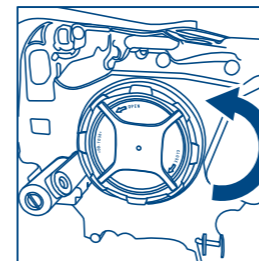

1 Îndepărtați capacul farului.

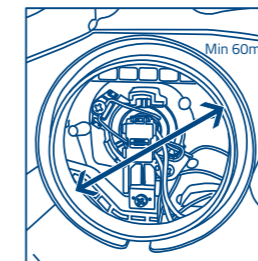

2 Asigurați-vă că diametrul interior este de cel puțin 60 mm.

### Pentru tipurile H1, H3 și H7

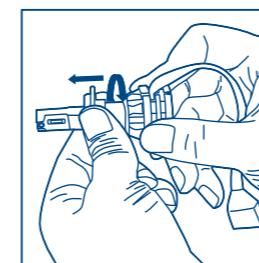

3 Scoateți inelul central și introduceți-l în suport. Fixați inelul cu clema metalică. Introduceți becul în suport. Răsuciți ușor becul pentru a-l fixa.

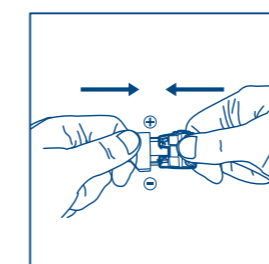
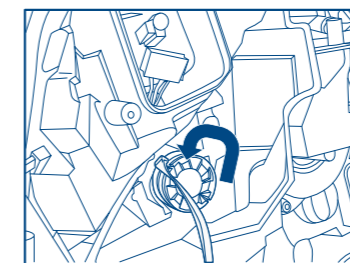

4 Conectați becul la conectorul mașinii (respectând polaritatea pentru tipurile H1 și H3).

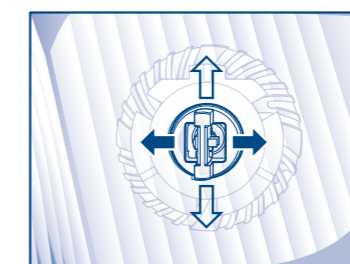

5 Asigurați-vă că arzătorul este poziționat vertical.

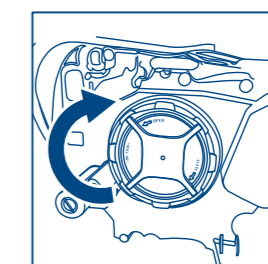

6 Sigilați capacul farului.

# DE CARE TIP DE UPGRADE DE LED AVEȚI NEVOIE?



## LUMINĂ DE INTERIOR LUMINĂ TORPEDO

## LUMINI PANOU DE BORD

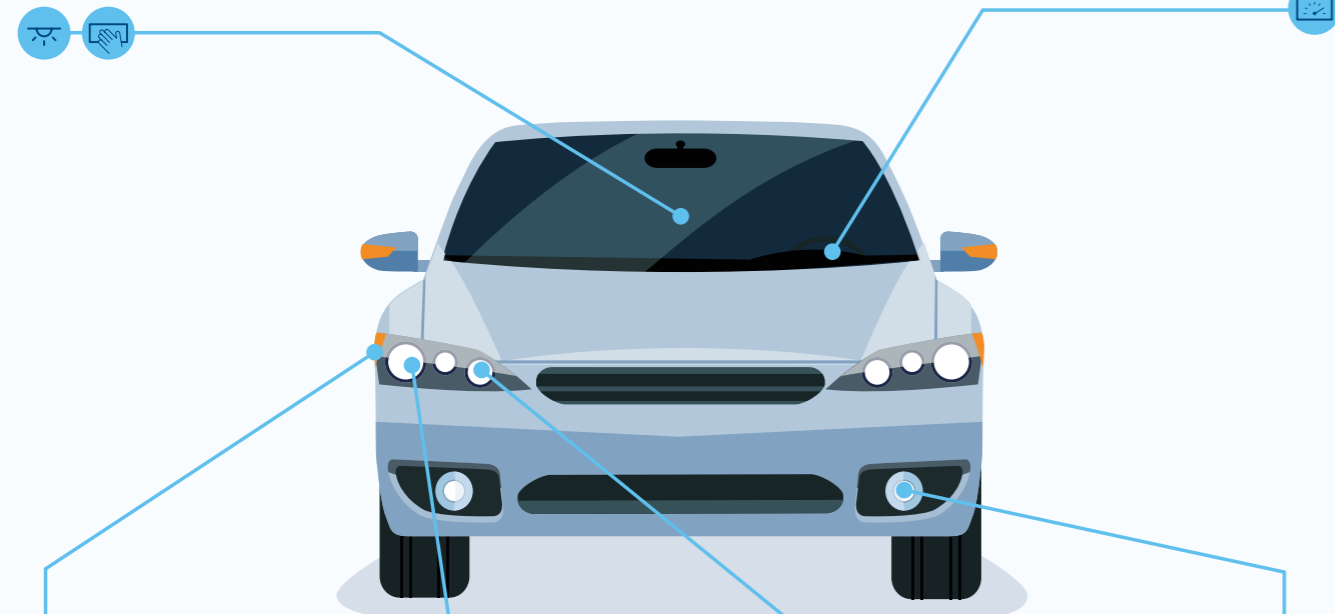

## SEMNALIZATOARE DIRECȚIE FAȚĂ



## FAZĂ SCURTĂ FAZĂ LUNGĂ

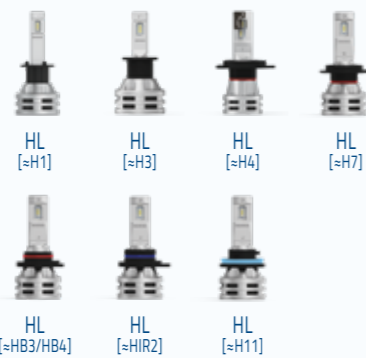

## PROIECTOARE CEAȚĂ

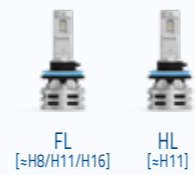

## SEMNALIZATOARE POZIȚIE



## SEMNALIZATOR FRĂNARE SUPLIMENTAR



## SEMNALIZATOARE DIRECȚIE SPATE

## PLĂCUȚĂ ÎNMATRICULARE



## LUMINĂ PORTBAGAJ



## PROIECTOARE CEAȚĂ

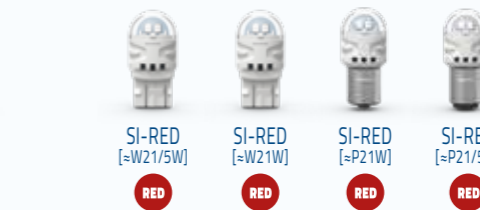



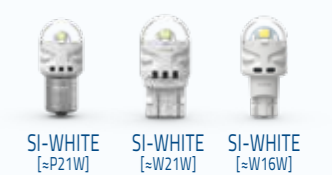





## SEMNALIZATOR MARȘARIER



## SEMNALIZATOARE FRĂNARE SEMNALIZATOARE POZIȚIE SPATE



LED

	Tip HL [≈H1]	Nr. ref. 0180573000	V 12/24	W 19	Bază P14,5s	Bucăți/PU 6	Ambalaj X2
	Tip HL [≈H3]	Nr. ref. 0180583000	V 12/24	W 19	Bază PK22s	Bucăți/PU 6	Ambalaj X2
	Tip HL [≈H4]	Nr. ref. 0180323000	V 12/24	W 24	Bază P43t-38	Bucăți/PU 6	Ambalaj X2
	Tip HL [≈H7]	Nr. ref. 0180333000	V 12/24	W 24	Bază PX26d	Bucăți/PU 6	Ambalaj X2
	Tip HL [≈H11]	Nr. ref. 0180483000	V 12/24	W 24	Bază PGJ19-2	Bucăți/PU 6	Ambalaj X2
	Tip FL [≈H8/H11/H16]	Nr. ref. 0180363000	V 12/24	W 24	Bază PGJ19-1	Bucăți/PU 6	Ambalaj X2
	Tip HL [≈HB3/HB4]	Nr. ref. 0180383000	V 12/24	W 24	Bază P20d/P22d	Bucăți/PU 6	Ambalaj X2
	Tip HL [≈HIR2]	Nr. ref. 0180443000	V 12/24	W 24	Bază PX22d	Bucăți/PU 6	Ambalaj X2











## SEMNALIZARE ŞI ILUMINAT INTERIOR

## RANGE PERFORMANCE

Tip	Nr. ref.	V	W	Bază	Bucăţi/PU	Ambalaj
 SI-WHITE [≈W5W]	0181454100	12	0.36	W2.1x9.5d	6	B2
 SI-WHITE [≈P21W]	0181484100	12	2.20	BA15S	6	B2
 SI-WHITE [≈W21W]	0180844100	12	2.20	W3x16d	6	B2
 SI-AMBER [≈PY21W]	0181494100	12	2.15	BAY15D	6	B2
 SI-AMBER [≈WY21W]	0181464100	12	2.15	WX3x16d	6	B2
 SI-RED [≈P21W]	0181514100	12	1.73	BA15S	6	B2
 SI-RED [≈W21W]	0180874100	12	1.73	W3x16d	6	B2
 SI-WHITE [≈P21/5W]	0181474100	12	2.4/0.48	BAY15D	6	B2
 SI-WHITE [≈W21/5W]	0180884100	12	2.4/0.48	W3x16q	6	B2
 SI-RED [≈P21/5W]	0181524100	12	1.75/0.65	BAY15D	6	B2

## SEMNALIZARE ŞI ILUMINAT INTERIOR

## RANGE PERFORMANCE

Tip	Nr. ref.	V	W	Bază	Bucăţi/PU	Ambalaj
 SI-RED [≈W21/5W]	0181694100	12	1.75/0.65	W3x16q	6	B2
 SI-WHITE [≈Fest 30 mm]	0181704000	12	0.80	SV8.5	6	B1
 SI-WHITE [≈Fest 38 mm]	0181714000	12	0.60	SV8.5	6	B1
 SI-WHITE [≈Fest 43 mm]	0181724000	12	0.60	SV8.5	6	B1
 SI-WHITE [≈W16W]	0181644000	12	1.80	W2.1x9.5d	6	B1
 SI-WHITE [≈R5/R10W]	0181654100	12	1.80	BA15s	6	B2



# SOLUȚII CU CONVENȚIONALE

## VEHICULE



ÎNLOCUIRE	DURABILITATE	VEDERE MAI BUNĂ		ELEGANȚĂ		
<b>Standard</b>	<b>Long Life</b>	<b>Range Power 50+</b>	<b>Range Power 150</b>	<b>Range Power Blue+</b>	<b>Range Power White</b>	<b>Rallye</b>
Raport bun calitate-preț	Perioadă de funcționare dublă	Cu până la 50% vedere mai bună	Cu până la 150% mai multă luminozitate	Cu până la 50% vedere mai bună, alb elegant	Alb xenon 4 500 K	Foarte strălucitor
		Neomologat pentru Europa*		Neomologat pentru Europa*		

## CAMIOANE



ÎNLOCUIRE	DURABILITATE	ELEGANȚĂ
<b>Standard</b>	<b>Heavy Duty</b>	<b>Rallye</b>
Raport bun calitate-preț	Rezistă la toate vibrațiile	Foarte strălucitor
		Neomologat pentru Europa*

\*Important Produsele care nu au logo de omologare CEE nu sunt omologate și nu pot fi vândute în Europa.



## SOLUȚII CU CONVENȚIONALE



## VEDERE MAI BUNĂ

### RANGE POWER 50+



### RANGE POWER 50+

Oferind cu până la 50% mai multă vizibilitate decât o lampă standard, gama noastră Power 50+ asigură un fascicul luminos mai lung pentru luminozitate sporită. Este concepută pentru ca șoferii să poată vedea mai departe și mai clar pentru siguranță superioară.



### RANGE POWER 150



### RANGE POWER 150

Noua gamă Power 150 oferă cu până la 150% mai multă luminozitate! Fasciculul luminos puternic permite șoferilor să vadă mai departe. Designul special al arzătorului creează un flux luminos mai mare pentru a beneficia de siguranță sporită și performanțe superioare.



## ÎNLOCUIRE

### STANDARD

Înlocuire este gama Standard NARVA. Aceasta reprezintă cea mai bună valoare, combinând fiabilitatea cu economia. Pentru șoferii care caută cel mai bun raport preț-performanță, fără a sacrifica siguranța, NARVA Core este alegerea perfectă.



## ELEGANȚĂ

### RANGE POWER BLUE+



### RANGE POWER BLUE+

Oferind cu până la 50% vedere mai bună și până la 30% lumină mai elegantă, CEE, gama noastră Power Blue+ este concepută pentru ca șoferii să vadă mai departe și mai clar, pentru vizibilitate și siguranță îmbunătățite. Efectul albastru elegant va face ca mașina să iasă în evidență.

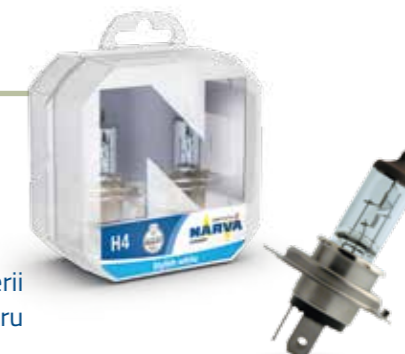

### RANGE POWER WHITE



### RANGE POWER WHITE\*

Gama Power White NARVA oferă o lumină albă strălucitoare și elegantă. Efectul de xenon elegant obținut prin temperatura culorii de 4.500 K conferă automobilului dumneavoastră un aspect atractiv aproape de lumina zilei. Gama Power White este alegerea perfectă pentru cei care caută să iasă în evidență.



\*Neomologat pentru Europa. Nu se poate vinde sau utiliza în Europa.

### RALLYE

### RALLYE\*

Oferind o putere mare pentru mai multă vizibilitate, gama Rallye este concepută pentru ca șoferii să vadă mai departe și mai clar.

\*Neomologat pentru Europa. Nu se poate vinde sau utiliza în Europa.



## DURABILITATE

### LONG LIFE

Gama noastră verde a fost special concepută pentru o durată mare de viață. Cu o durată de viață dublă față de lămpile standard, aceste becuri rezistente nu trebuie înlocuite la fel de des, ceea ce înseamnă mai puțină întreținere și un impact minim asupra mediului.





# DE CARE TIP DE LAMPĂ DE 12V AVEȚI NEVOIE?

**LUMINĂ TORPEDO**  
W5W 17177, C5W 17125, R5W 17171

**LUMINĂ DE INTERIOR**  
W5W 17177, C5W 17125, C10W 17314, H10W 17833

**LUMINI PANOU DE BORD**  
W3W 17097, W5W 17177, W1,2W 17037, BAX -

**SEMNALIZATOARE DIRECȚIE LATERALE**  
W3W 17097, W5W 17177, WY5W 17169  
T4W 17131, H21W 68191, C5W 17125

**PROIECTOARE CEAȚĂ**  
H1 48320, H3 48321, H4 48881  
H7 48328, H8 48076, HB3 48005  
H27W/1 48041, H27W/2 48042  
800 series -

**FAZĂ SCURTĂ  
FAZĂ LUNGĂ  
LUMINI PENTRU ILUMINAT PE TIMP DE ZI**  
R2 49211, R2 halogen 48121, S2 49531, H1 48320, H2 48420, H3 48321, H4 48881  
H7 48328, H8 48076, H9 48077, H10 48095, H11 48078, H12 - 48092, H13 48092  
H15 48070, HIR2 48067, HB1 48004, HB2 48882, HB3 48005, HB4 48006, HB5 48007

**SEMNALIZATOARE DIRECȚIE FAȚĂ**  
P21W 17635, PY21W 17638, WY5W 17169, W21W 17632

**SEMNALIZATOARE POZIȚIE**  
W3W 17097, W5W 17177, W21W 17632, W21W/5W 17919  
H27W/1 48041, H27W/2 48042

**SEMNALIZATOARE DIRECȚIE SPATE**  
P21W 17635, PY21W 17638, R10W 17311, W16W 17631, W21W 17632, H6W 68161, H21W 68191

**SEMNALIZATOR FRÂNARE SUPPLEMENTAR**  
W3W 17097, W5W 17177, W16W 17631, W21W 17632, W2,3W 17073, R10W 17311, P21W 17635

**SEMNALIZATOARE DIRECȚIE SPATE**  
P21W 17635, PY21W 17638, R10W 17311, W16W 17631, W21W 17632, H6W 68161, H21W 68191

**PLĂCUȚĂ ÎNMATRICULARE**  
R5W 17171, R10W 17311, C5W 17125  
W3W 17097, W5W 17177, T4W 17131

**LUMINĂ PORTBAGAJ**  
R5W 17171, C5W 17125, C10W 17314

**SEMNALIZATOR MARȘARIER**  
P21W 17635, H6W 68161, H21W 68191  
W16W 17631, W21W 17632, R10W 17311

**SEMNALIZATOARE POZIȚIE SPATE**  
H6W 68161, R5W 17171, R10W 17311

**SEMNALIZATOARE FRÂNARE**  
P21W/5W 17916, P21W/4W 7881, P21W 17635, W16W 17631, W21W 17632, W21W/5W 17919, R5W 17171

**PROIECTOARE CEAȚĂ**  
P21W 17635, P21W/5W 17916, H21W 68191, W16W 17631, W21W 17632



# VEHICULE

## LĂMPI DE 12V

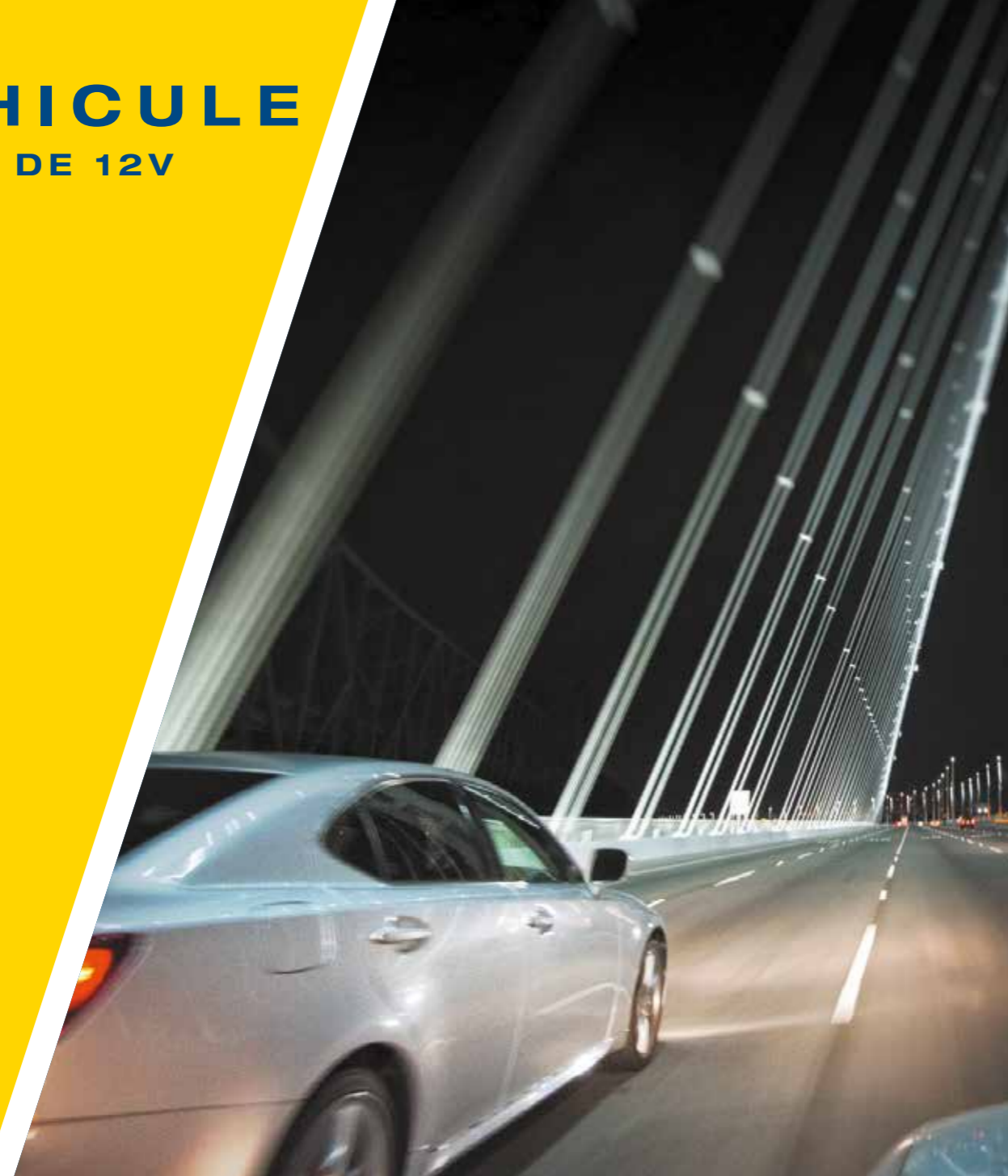











**NARVA** este recunoscută pentru producerea de soluții de iluminat cu halogen de calitate, care sunt durabile și fiabile.

Becurile noastre cu halogen oferă o vizibilitate mai mare și o siguranță sporită în toate condițiile de condus.

### LĂMPI PENTRU FARURI











STANDARD

	CEE	Nr. ref.	V	W	Bază	Bucăți/PU	Ambalaj
	H1	483203000	12	55	P14,5s	100	C1
		483204000	12	55	P14,5s	10	B1
	H2	484203000	12	55	X511	100	C1
	H3	483213000	12	55	PK22s	100	C1
		483214000	12	55	PK22s	10	B1
	H4	488813000	12	60/55	P43t	100	C1
		488814000	12	60/55	P43t-38	10	B1
	H7	483283000	12	55	PX26d	100	C1
		483284000	12	55	PX26d	10	B1
	H8	480763000	12	55	PGJ19-1	100	C1
	H9	480773000	12	65	PGJ19-5	100	C1
	H10 (9145)	480953000	12	42	PY20d	100	C1
	H11	0480723000	12	55	PGJ19-2	100	C1
	H13 (9008)	480923000	12	60/55	P26,4t	100	C1



## LĂMPI PENTRU FARURI

### STANDARD

	CEE	Nr. ref.	V	W	Bază	Bucăți/PU	Ambalaj
	H15	480703000	12	15/55	PGJ23t-1	100	C1
	HIR2	480673000	12	55	PX22d	100	C1
	R2 Halogen	481213000	12	45/40	P45t-41	100	C1
	R2	492113000	12	45/40	P45t	100	C1
	H27W/1	480413000	12	27	PG13	100	C1
	H27W/2	480423000	12	27	PG13	100	C1
	S2	495313000	12	35/35	BA20d	200	C1
	HB1	480043000	12	65/45	P29t	100	CP
	HB2	488823000	12	67/60	P43t-38	100	C1
	HB3	480053000 480054000	12 12	60 60	P20d P20d	100 10	C1 B1

	CEE	Nr. ref.	V	W	Bază	Bucăți/PU	Ambalaj
	HB4	480063000 480064000	12 12	51 51	P22d P22d	100 10	C1 B1

	CEE	Nr. ref.	V	W	Bază	Bucăți/PU	Ambalaj
	HB5	480073000	12	65/55	PX29t	100	C1

## LĂMPI PENTRU FARURI

### LONG LIFE

	CEE	Nr. ref.	V	W	Bază	Bucăți/PU	Ambalaj
	H1 LL	483223000	12	55	P14,5s	100	C1

	CEE	Nr. ref.	V	W	Bază	Bucăți/PU	Ambalaj
	H4 LL	488893000	12	60/55	P43t-38	100	C1

	CEE	Nr. ref.	V	W	Bază	Bucăți/PU	Ambalaj
	H7 LL	483293000	12	55	PX26d	100	C1

	CEE	Nr. ref.	V	W	Bază	Bucăți/PU	Ambalaj
	H11 LL	480783000	12	55	PGJ19-2	100	C1





	CEE	Nr. ref.	V	W	Bază	Bucăți/PU	Ambalaj
	862 LL	480595000	12	37,5	PGJ13	300	CP









## LĂMPI PENTRU FARURI

## RANGE POWER 50+

	CEE	Nr. ref.	V	W	Bază	Bucăți/PU	Ambalaj
	H1	483343000	12	55	P14,5s	100	C1
	RP50+	483344000	12	55	P14,5s	10	B1
		483342100	12	55	P14,5s	10	S2
	H3	483353000	12	55	PK22s	100	C1
	RP50+						
	H4	488613000	12	60/55	P43t-38	100	C1
	RP50+	488614000	12	60/55	P43t-38	10	B1
		488612100	12	60/55	P43t-38	10	S2
	H7	483393000	12	55	PX26d	100	C1
	RP50+	483394000	12	55	PX26d	10	B1
		483392100	12	55	PX26d	10	S2

## LĂMPI PENTRU FARURI

## RANGE POWER 150

	CEE	Nr. ref.	V	W	Bază	Bucăți/PU	Ambalaj
	H1	480682100	12	55	P14,5s	10	S2
	RP150						
	H4	480692100	12	60/55	P43t-38	10	S2
	RP150						
	H7	480712100	12	55	PX26d	10	S2
	RP150						
	H11	481012100	12	55	PGJ19-2	10	S2
	RP150						

## LĂMPI PENTRU FARURI

## RANGE POWER BLUE+

	CEE	Nr. ref.	V	W	Bază	Bucăți/PU	Ambalaj
	H1	486303000	12	55	P14,5s	100	C1
	RPB+	486304000	12	55	P14,5s	10	B1
		486302100	12	55	P14,5s	10	S2
	H3	486333000	12	55	PK22s	100	C1
	RPB+						
	H4	486773000	12	60/55	P43t-38	100	C1
	RPB+	486774000	12	60/55	P43t-38	10	B1
		486772100	12	60/55	P43t-38	10	S2
	H7	486383000	12	55	PX26d	100	C1
	RPB+	486384000	12	55	PX26d	10	B1
		486382100	12	55	PX26d	10	S2
	HB2	486763000	12	67/60	P43t-38	100	C1
	RPB+						
	HB3	486163000	12	60	P20d	100	C1
	RPB+						
	HB4	486133000	12	51	P22d	100	C1
	RPB+						
	HB5	486293000	12	65/55	PX29t	100	C1
	RPB+						



## LĂMPI PENTRU FARURI









## RANGE POWER WHITE\*

Tip	Nr. ref.	V	W	Bază	Bucăți/PU	Ambalaj
 H1 RPW	486412100	12	55	P14,5s	10	S2
 H3 RPW	486022100	12	55	PK22s	10	S2
 H4 RPW	486802100	12	60/55	P43t-38	10	S2
 H7 RPW	486072100	12	55	PX26d	10	S2
 HB3 (9005) RPW	486252100	12	65	P20d	10	S2
 HB4 (9006) RPW	486262100	12	55	P22d	10	S2
 H1/W5W PW kit	980142100	H1 W5W	85 5	P14,5s W2,1x9,5d	2 2	SM
 H4/W5W PW kit	980152100	H4 W5W	100/90 5	P43t W2,1x9,5d	2 2	SM
 H7/W5W PW kit	980162100	H7 W5W	85 5	PX26d W2,1x9,5d	2 2	SM

\*Important Produsele care nu au logo de omologare CEE nu sunt omologate și nu pot fi vândute în Europa.

## LĂMPI PENTRU FARURI

## RALLYE\*











Tip	Nr. ref.	V	W	Bază	Bucăți/PU	Ambalaj
 H1 Rallye	483503000 483803000	12 12	100 130	P14,5s P14,5s	100 100	C1 C1
 H3 Rallye	483513000 483813000	12 12	100 130	PK22s PK22s	100 100	C1 C1
 H4 Rallye P43t	489013000 489014000 489113000 489513000	12 12 12 12	100/90 100/90 100/55 130/100	P43t-38 P43t-38 PX26d P43t	100 10 100 100	C1 B1 C1 C1
 H4 Rallye P45t	488843000 489043000	12 12	60/55 100/90	P45t P45t-41	100 100	C1 C1
 H7 Rallye	483583000	12	80	PX26d	100	C1
 HB1 Rallye	480343000	12	100/80	P29t	100	C1
 HB3 Rallye	480253000	12	100	P20d	100	C1
 HB4 Rallye	480263000	12	70	P22d	100	C1
 HB5 Rallye	480313000	12	100/80	PX29t	100	C1







\*Important Produsele care nu au logo de omologare CEE nu sunt omologate și nu pot fi vândute în Europa.



LĂMPI PENTRU FARURI

TIPURI AMERICANE

Tip SUA	Nr. ref.	V	W	Bază	Bucăți/PU	Ambalaj
 9004 (HB1)	480043000	12	65/45	P29t	100	CP
 9003 (HB2)	488823000	12	67/60	P43t-38	100	C1
 9005 (HB3)	480053000 480054000	12 12	60 60	P20d P20d	100 10	C1 B1
 9006 (HB1)	480063000 480064000	12 12	51 51	P22d P22d	100 10	C1 B1
 9007 (HB5)	480073000	12	65/45	PX29t	100	C1
 9008 (H13)	480923000	12	60/55	P26,4t	100	C1
 9145 (H10)	480953000	12	42	Y20d	100	C1
 880	480393000	12,8	27	PG13	100	C1
 881	480403000	12,8	27	PGJ13	100	C1
 885	480553000	12,8	50	PG13	100	C1

Tip SUA	Nr. ref.	V	W	Bază	Bucăți/PU	Ambalaj
 886	480563000	12,8	50	PGJ13	100	C1
 889	480453000	12,8	27	PGJ13	100	C1
 890	480463000	12,8	27	PG13	100	C1
 893	480513000	12,8	37,5	PG13	100	C1
 894	480543000	12,8	37,5	PGJ13	100	C1
 896	480523000	12,8	37,5	PGJ13	100	C1





















## SEMNALIZARE ŞI ILUMINAT INTERIOR

### STANDARD





	CEE (Stop P22)	Nr. ref. 174113000	V 12	W 15	Bază BA15s	Bucăţi/PU 200	Ambalaj CP
	CEE (Stop P25) BA15s	Nr. ref. 175113000	V 12	W 18	Bază BA15s	Bucăţi/PU 200	Ambalaj CP
	CEE P21W	Nr. ref. 176353000 176354000 176403000	V 12 12 12	W 21 21 21	Bază BA15s BA15s BAU15s	Bucăţi/PU 200 10 200	Ambalaj CP B2 CP
	CEE PY21W Amber	Nr. ref. 176383000 176384000	V 12 12	W 21 21	Bază BAU15s BAU15s	Bucăţi/PU 200 10	Ambalaj CP B2

	CEE P21/4W	Nr. ref. 178813000 178814000	V 12 12	W 21/4 21/4	Bază BAZ15d PX26d	Bucăţi/PU 200 10	Ambalaj CP B2
	CEE P21/5W	Nr. ref. 179163000 179164000	V 12 12	W 21/5 21/5	Bază BAY15d BAY15d	Bucăţi/PU 200 10	Ambalaj CP B2
	CEE (Stop P25) BA15d	Nr. ref. 179183000	V 12	W 21/5	Bază BA15d	Bucăţi/PU 200	Ambalaj CP
	CEE R5W BA15s	Nr. ref. 171713000 171714000	V 12 12	W 5 5	Bază BA15s BA15s	Bucăţi/PU 200 10	Ambalaj CP B2
	CEE R5W BA15d	Nr. ref. 171723000	V 12	W 5	Bază BA15d	Bucăţi/PU 200	Ambalaj CP
	CEE R10W	Nr. ref. 173113000 173114000	V 12 12	W 10 10	Bază BA15s BA15s	Bucăţi/PU 200 10	Ambalaj CP B2
	CEE RY10W	Nr. ref. 173173000	V 12	W 10	Bază BAU15s	Bucăţi/PU 200	Ambalaj CP
	CEE	Nr. ref. 170513000	V 12	W 2	Bază BA7s	Bucăţi/PU 200	Ambalaj CP
	CEE	Nr. ref. 170533000	V 12	W 2	Bază BA9s	Bucăţi/PU 200	Ambalaj CP
	CEE T4W	Nr. ref. 171313000	V 12	W 4	Bază BA9s	Bucăţi/PU 200	Ambalaj CP







## SEMNALIZARE ŞI ILUMINAT INTERIOR

LĂMPI MINIATURALE  
CU HALOGEN

	CEE	Nr. ref.	V	W	Bază	Bucăţi/PU	Ambalaj
	(H5W)	178303000	12	5	BA9s	200	CP
	H6W	681613000	12	6	BAX9s	200	CP
	(H10W)	178333000	12	10	BA9s	200	CP
	(H20W)	178353000	12	20	BA9s	200	CP
	H21W	681913000	12	21	BAY9s	200	CP

## SEMNALIZARE ŞI ILUMINAT INTERIOR

LĂMPI INDICATOARE  
CU BAZĂ TIP PANĂ

	CEE	Nr. ref.	V	W	Bază	Bucăţi/PU	Ambalaj
	(W1,2W) Frosted	170323000	12	1,2	W2x4,6d	200	CP
	(W1,2W)	170373000	12	1,2	W2x4,6d	200	CP
	(W2,2W)	170593000	12	2,2	W2,1x9,5d	200	CP
	W2,3W	170733000	12	2,3	W2x4,6d	200	CP

	CEE	Nr. ref.	V	W	Bază	Bucăţi/PU	Ambalaj
	W3W	170973000	12	3	W2,1x9,5d	200	CP

	CEE	Nr. ref.	V	W	Bază	Bucăţi/PU	Ambalaj
	W5W	171773000 171774000	12 12	5 5	W2,1x9,5d W2,1x9,5d	200 10	CP B2

	CEE	Nr. ref.	V	W	Bază	Bucăţi/PU	Ambalaj
	WY5W	171693000	12	5	W2,1x9,5d	200	CP

	CEE	Nr. ref.	V	W	Bază	Bucăţi/PU	Ambalaj
	W16W	176313000	12	16	W2,1x9,5d	200	CP

	CEE	Nr. ref.	V	W	Bază	Bucăţi/PU	Ambalaj
	W21W	176323000	12	21	W3x16d	200	CP

	CEE	Nr. ref.	V	W	Bază	Bucăţi/PU	Ambalaj
	WY21W	176293000	12	21	WX3x16d	200	CP

	CEE	Nr. ref.	V	W	Bază	Bucăţi/PU	Ambalaj
	W21/5W	179193000	12	21/5	W3x16q	200	CP

## SEMNALIZARE ŞI ILUMINAT INTERIOR

## LĂMPI FESTOON

	CEE	Nr. ref.	V	W	Bază	Bucăţi/PU	Ambalaj
	T8.2x30	170943000	12	3	SV7,5	200	CP

	CEE	Nr. ref.	V	W	Bază	Bucăţi/PU	Ambalaj
	C5W	171253000 171254000	12 12	5 5	SV8,5 SV8,5	200 10	CP B2





	CEE	Nr. ref.	V	W	Bază	Bucăți/PU	Ambalaj
	T10.5x43	171753000	12	5	SV8,5	200	CP

	CEE	Nr. ref.	V	W	Bază	Bucăți/PU	Ambalaj
	T10.5x43	173143000	12	10	SV8,5	200	CP

	CEE	Nr. ref.	V	W	Bază	Bucăți/PU	Ambalaj
	T10.5x30	173153000	12	10	SV8,5	200	CP

	CEE	Nr. ref.	V	W	Bază	Bucăți/PU	Ambalaj
	T10.5x38	173163000	12	10	SV8,5	200	CP

	CEE	Nr. ref.	V	W	Bază	Bucăți/PU	Ambalaj
	T15x43	175123000	12	18	SV8,5	200	CP

	CEE	Nr. ref.	V	W	Bază	Bucăți/PU	Ambalaj
	C21W	176343000	12	21	SV8,5	200	CP

### SEMNALIZARE ȘI ILUMINAT INTERIOR

### LĂMPI CU BAZĂ DIN PLASTIC (BAX)

	CEE	Nr. ref.	V	W	Bază	Bucăți/PU	Ambalaj
		170063000	12	0,4	Bax 8,5d blue violet	200	CP

	CEE	Nr. ref.	V	W	Bază	Bucăți/PU	Ambalaj
		170193000	12	1	Bax 8,5d orange	200	CP

	CEE	Nr. ref.	V	W	Bază	Bucăți/PU	Ambalaj
		170273000	12	1,2	Bax 8,4d light blue	200	CP

	CEE	Nr. ref.	V	W	Bază	Bucăți/PU	Ambalaj
		170283000	12	1,2	Bax 8,4d black	200	CP

	CEE	Nr. ref.	V	W	Bază	Bucăți/PU	Ambalaj
		170293000	12	1,2	Bax 8,5d blue	200	CP

	CEE	Nr. ref.	V	W	Bază	Bucăți/PU	Ambalaj
		170353000	12	1,2	Bax 8,5d black	200	CP

	CEE	Nr. ref.	V	W	Bază	Bucăți/PU	Ambalaj
		170363000	12	1,2	Bax 8,3d black	200	CP

	CEE	Nr. ref.	V	W	Bază	Bucăți/PU	Ambalaj
		170463000	12	1,1	Bax 8,4d orange	200	CP

	CEE	Nr. ref.	V	W	Bază	Bucăți/PU	Ambalaj
		170473000	12	1,3	Bax 8,4d olive green	200	CP

	CEE	Nr. ref.	V	W	Bază	Bucăți/PU	Ambalaj
		170483000	12	1,5	Bax 8,4d beige	200	CP





	CEE	Nr. ref.	V	W	Bază	Bucăți/PU	Ambalaj
		170493000	12	1,5	Bax 8,5d beige	200	CP

	CEE	Nr. ref.	V	W	Bază	Bucăți/PU	Ambalaj
		170503000	12	1,5	Bax 8,5d yellow	200	CP

	CEE	Nr. ref.	V	W	Bază	Bucăți/PU	Ambalaj
		170523000	12	2	Bax 8,5d light green	200	CP







	CEE	Nr. ref.	V	W	Bază	Bucăți/PU	Ambalaj
		170543000	12	2	Bax 8,4d light green	200	CP
	CEE	Nr. ref.	V	W	Bază	Bucăți/PU	Ambalaj
		170573000	12	2	Bax 8,5d green	200	CP
	CEE	Nr. ref.	V	W	Bază	Bucăți/PU	Ambalaj
		170583000	12	2	Bax 8,3d blue	200	CP
	CEE	Nr. ref.	V	W	Bază	Bucăți/PU	Ambalaj
		170603000	12	1,8	Bax 8,4d beige	200	CP
	CEE	Nr. ref.	V	W	Bază	Bucăți/PU	Ambalaj
		171633000	12	5	Bax 10d black	100	C1



## SEMNALIZARE ȘI ILUMINAT INTERIOR

## RANGE POWER BLUE+

	CEE	Nr. ref.	V	W	Bază	Bucăți/PU	Ambalaj
	W5W RPB+	171893000	12	5	W2,1x9,5d	200	CP
	CEE	Nr. ref.	V	W	Bază	Bucăți/PU	Ambalaj
	H6W RPB+	681633000	12	6	BAX9s	200	CP

## SEMNALIZARE ȘI ILUMINAT INTERIOR

## TIPURI AMERICANE

	Tip SUA	Nr. ref.	V	W	Bază	Bucăți/PU	Ambalaj
	3156	179413000	12,8	32CP	W2,5x16d	200	CP
	Tip SUA	Nr. ref.	V	W	Bază	Bucăți/PU	Ambalaj
	3157	179453000	12,8/14	32/3CP	W2,5x16q	200	CP
	Tip SUA	Nr. ref.	V	W	Bază	Bucăți/PU	Ambalaj
	3157 NA	179483000	12,8/14	24/2,2CP	W2,5x16q	200	CP

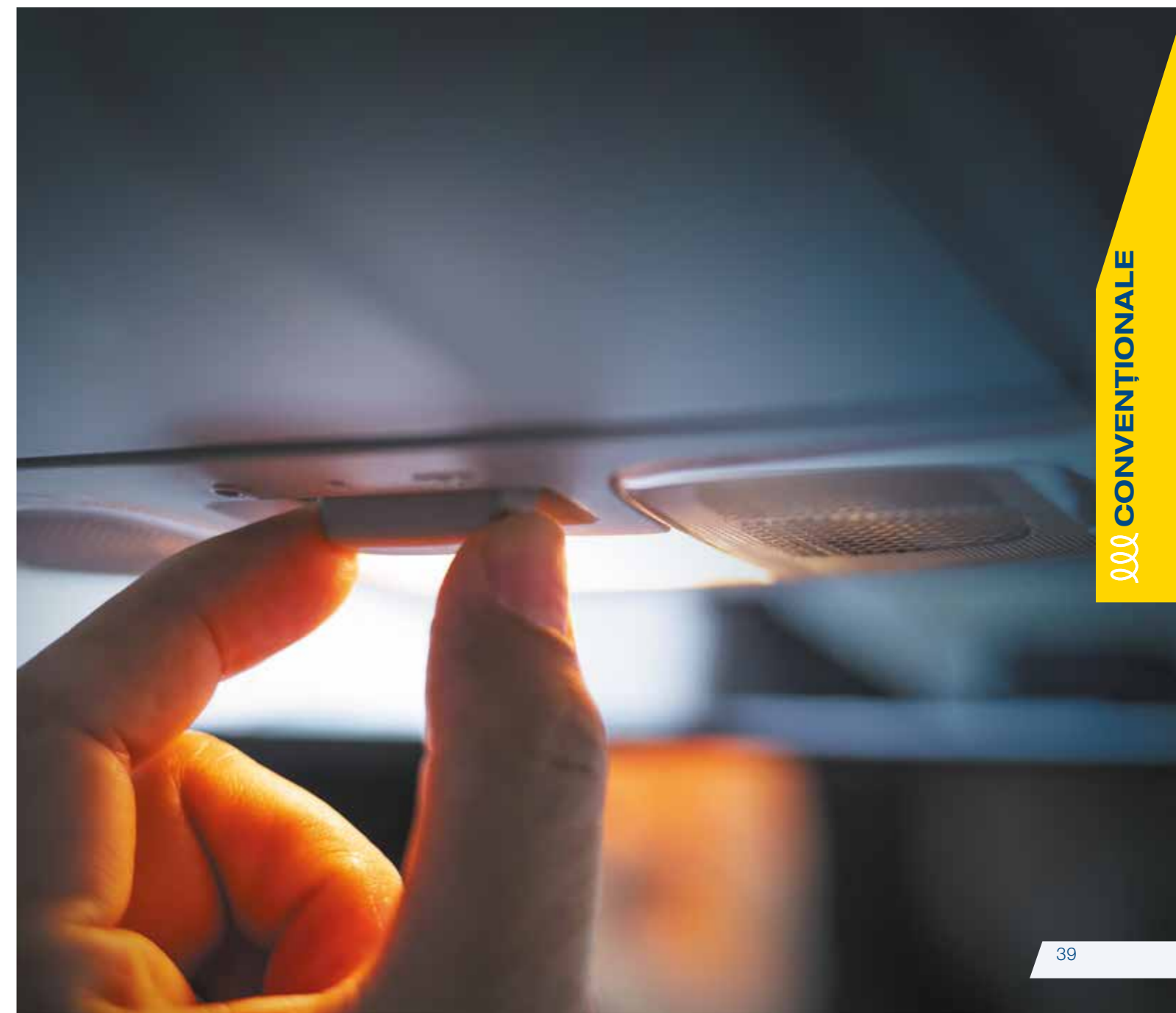





## SETURI DE REZERVĂ



### STANDARD

În multe dintre țările europene este obligatoriu sau se recomandă să aveți un set de rezervă în vehicul. Seturile noastre de rezervă oferă șoferilor siguranța de care au nevoie pe drum sau în timpul deplasărilor.

Descriere	Nr. ref.	Conținut	W	Bază	Nr. bucăți
 Set de rezervă mini H4	980043010	H4	60/55	P43t	1
		P21W	21	BA15s	1
		R5W	5	BA15s	1
		W5W	5	W2,1x9,5d	1
		Flat fuse			2
		Cantitate ambalaj			20
 Set de rezervă H4	984003010	H4	60/55	P43t	1
		P21/5W	21/5	BAY15d	1
		P21W	21	BA15s	1
		R5W	5	BA15s	1
		C5W	5	SV8,5	1
		W5W	5	W2,1x9,5d	1
		Flat fuse			4
		Cantitate ambalaj			20
 Set de rezervă H7/H1	984353010	H7	55	PX26d	1
		17	55	P14,5s	1
		P21/5W	21/5	BAY15d	1
		P21W	21	BA15s	1
		PY21W	21	BAU15s	1
		C5W	5	SV8,5	1
		W5W	5	W2,1x9,5d	1
		Flat fuse			4
		Cantitate ambalaj			20

## SETURI DE REZERVĂ

### RANGE POWER WHITE\*

Descriere	Nr. ref.	Conținut	W	Bază	Nr. bucăți
 Set RPW H1/W5W	980142100	H1	85	P14,5s	2
		W5W	5	W2,1x9,5d	2
		Cantitate ambalaj			10
 Set RPW H1/W5W	980152100	H4	100/90	P43t	2
		W5W	5	W2,1x9,5d	2
		Cantitate ambalaj			10
 Set RPW H7/W5W	980162100	H7	85	P14,5s	2
		W5W	5	W2,1x9,5d	2
		Cantitate ambalaj			10

\*Important Produsele care nu au logo de omologare CEE nu sunt omologate și nu pot fi vândute în Europa.

## 12V INSTRUMENTE PENTRU VÂNZĂRI

	<b>Stand pentru tejghea</b> <b>GOC: 98027700</b> Livrat cu <ul style="list-style-type: none"> <li>20x H7 Standard C1</li> <li>10x H4 Standard C1</li> </ul>		<b>Stand pentru podea</b> <b>GOC: 99026700</b> Stand pentru podea din carton durabil, livrat gol. <ul style="list-style-type: none"> <li>12 cârlige</li> <li>Panou header interschimbabil</li> </ul>	
	<b>Dozator de perete 12V</b> <b>GOC (gol): 980173000</b> <b>GOC (plin): 980223000</b> Livrat gol sau plin cu lămpi (vedeți structura de mai jos). carcasă metalică rezistentă Dimensiune compactă: 37 x 17,6 x 59,5 cm Poate fi încuiat Livrat cu <table border="0"> <tr> <td> <ul style="list-style-type: none"> <li>10x H1</li> <li>10x H3</li> <li>30x H4</li> <li>50x H7</li> <li>30x P21/5W</li> </ul> </td> <td> <ul style="list-style-type: none"> <li>30x P21W</li> <li>30x R5W BA15</li> <li>30x R10W</li> <li>30x T4W</li> <li>30x C5W</li> </ul> </td> <td> <ul style="list-style-type: none"> <li>20x Fest T10,5x43</li> <li>20x W1,2W</li> <li>20x W3W</li> <li>30x W5W</li> </ul> </td> </tr> </table>		<ul style="list-style-type: none"> <li>10x H1</li> <li>10x H3</li> <li>30x H4</li> <li>50x H7</li> <li>30x P21/5W</li> </ul>	<ul style="list-style-type: none"> <li>30x P21W</li> <li>30x R5W BA15</li> <li>30x R10W</li> <li>30x T4W</li> <li>30x C5W</li> </ul>
<ul style="list-style-type: none"> <li>10x H1</li> <li>10x H3</li> <li>30x H4</li> <li>50x H7</li> <li>30x P21/5W</li> </ul>	<ul style="list-style-type: none"> <li>30x P21W</li> <li>30x R5W BA15</li> <li>30x R10W</li> <li>30x T4W</li> <li>30x C5W</li> </ul>	<ul style="list-style-type: none"> <li>20x Fest T10,5x43</li> <li>20x W1,2W</li> <li>20x W3W</li> <li>30x W5W</li> </ul>		



# CAMIOANE

## LĂMPI DE 24V



Combinând rezistența la vibrații cu înalta calitate, gamele noastre de iluminat de 24V sunt robuste și fiabile pentru camioanele moderne și alte vehicule grele.

LĂMPI PENTRU FARURI pentru camioane de la **NARVA** oferă rezistență la vibrații și calitate superioară.

Verificați gama noastră de 24V atunci când rezistența și durabilitatea sunt necesare.

## DE CARE TIP DE LAMPĂ DE 24V AVEȚI NEVOIE?

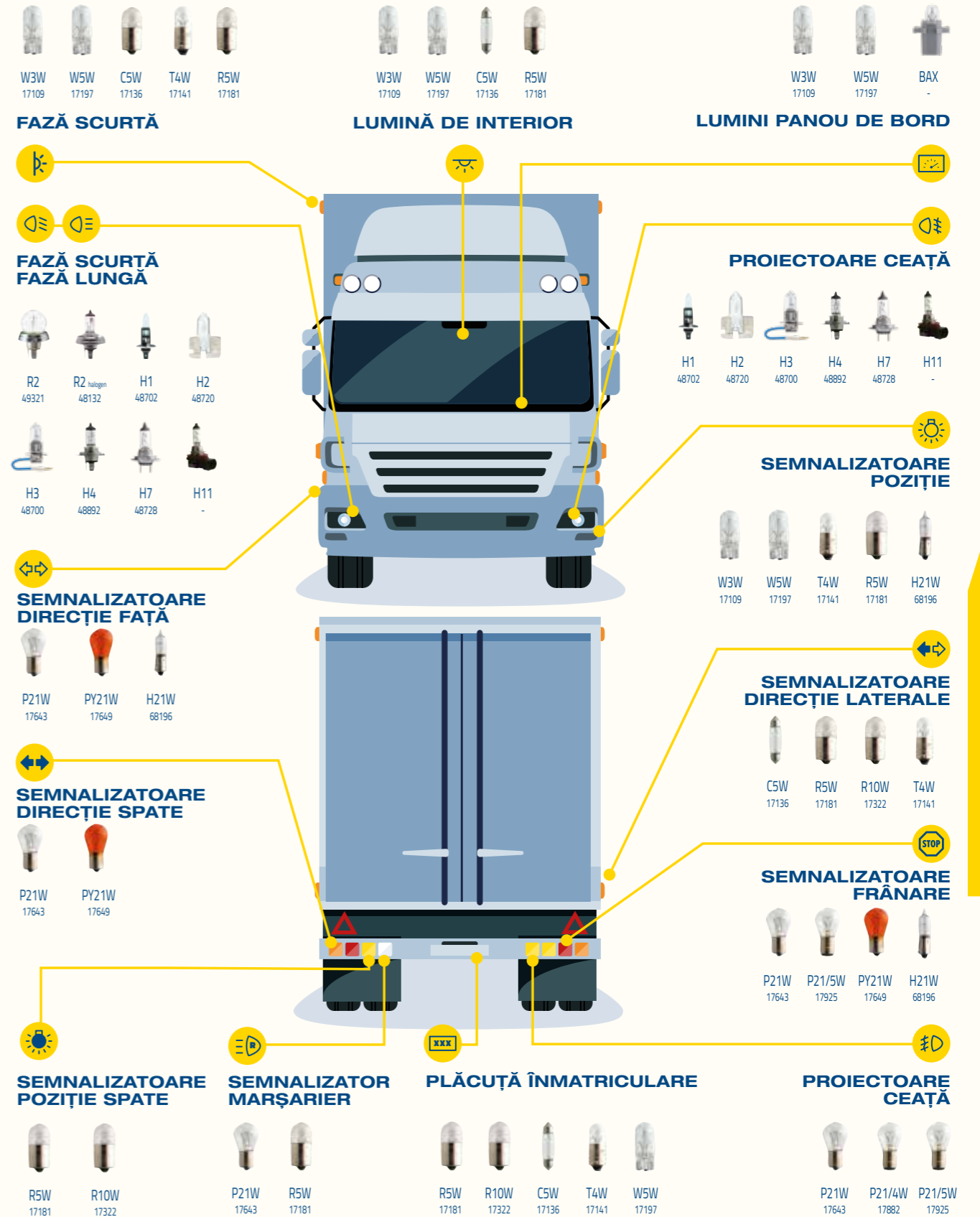







## LĂMPI PENTRU FARURI

## STANDARD

	CEE	Nr. ref.	V	W	Bază	Bucăți/PU	Ambalaj
	H1	487023000	24	70	P14,5s	100	C1
		487024000	24	70	P14,5s	10	B1
	H2	487203000	24	70	X511	100	C1
	H3	487003000	24	70	PK22s	100	C1
	H4	488923000	24	75/70	P43t	100	C1
		488924000	24	75/70	P43t-38	10	B1
	H7	487283000	24	70	PX26d	100	C1
		487284000	24	70	PX26d	10	B1
	R2 Halogen	481323000	24	55/50	P45t-41	100	C1
	R2	493213000	24	55/50	P45t	100	C1





## LĂMPI PENTRU FARURI

## HEAVY DUTY

	CEE	Nr. ref.	V	W	Bază	Bucăți/PU	Ambalaj
	H1 HD	487083000	24	70	P14,5s	100	C1
	H3 HD	487093000	24	70	PK22s	100	C1
	H4 HD	488983000	24	75/70	P43t-38	100	C1
	H7 HD	487293000	24	70	PX26d	100	C1

## LĂMPI PENTRU FARURI

## RALLYE\*











	Tip	Nr. ref.	V	W	Bază	Bucăți/PU	Ambalaj
	H1 Rallye	483503000	12	100	P14,5s	100	C1
		483803000	12	130	P14,5s	100	C1
	H3 Rallye	483513000	12	100	PK22s	100	C1
		483813000	12	130	PK22s	100	C1
	H4 Rallye P43t	489013000	12	100/90	P43t-38	100	C1
		489014000	12	100/90	P43t-38	10	B1
		489113000	12	100/55	PX26d	100	C1
		489513000	12	130/100	P43t	100	C1
	H4 Rallye P45t	488843000	12	60/55	P45t	100	C1
		489043000	12	100/90	P45t-41	100	C1

\*Important Produsele care nu au logo de omologare CEE nu sunt omologate și nu pot fi vândute în Europa.



## SEMNALIZARE ŞI ILUMINAT INTERIOR

STANDARD

	CEE	Nr. ref.	V	W	Bază	Bucăţi/PU	Ambalaj
		179273000	24	21/5	BA15d	200	CP
	P21W	176433000 176434000	24 24	21 21	BA15s BA15s	200 10	CP B2
	P21/4W	178823000	24	21/4	BAZ15d	200	CP
	P21/5W	179253000	24	21/5	BAY15d	200	CP
	Stop P22	174213000	24	15	BA15s	200	CP
	R5W BA15s	171813000 171814000	24 24	5 5	BA15s BA15s	200 10	CP B2
	R5W	171823000	24	5	BA15d	200	CP
	R10W	173223000	24	10	BA15d	200	CP
		170613000	24	3	BA7s	200	CP
		170633000	24	2	BA9s	200	CP



CEE	Nr. ref.	V	W	Bază	Bucăţi/PU	Ambalaj
T4W	171413000	24	4	BA9s	200	CP

## SEMNALIZARE ŞI ILUMINAT INTERIOR

LĂMPI MINIATURALE  
CU HALOGEN

CEE	Nr. ref.	V	W	Bază	Bucăţi/PU	Ambalaj
H21W	681963000	24	21	BAY9s	200	CP



24V | CAMIOANE |



CONVENTIONALE





## SEMNALIZARE ŞI ILUMINAT INTERIOR

LĂMPI INDICATOARE  
CU BAZĂ TIP PANĂ

	CEE	Nr. ref.	V	W	Bază	Bucăţi/PU	Ambalaj
	(W1,2W)	170403000	24	1,2	W2x4,6d	200	CP
	W3W	171093000	24	3	W2,1x9,5d	200	CP
	W5W	171973000	24	5	W2,1x9,5d	200	CP











## SEMNALIZARE ŞI ILUMINAT INTERIOR

## LĂMPI FESTOON

	CEE	Nr. ref.	V	W	Bază	Bucăţi/PU	Ambalaj
	T8.2x30	171043000	24	3	SV7,5	200	CP
	C5W	171363000	24	5	SV8,5	200	CP
	T10.5x43	171853000	24	5	SV8,5	200	CP
	T10.5x43	173273000	24	10	SV8,5	200	CP
	T15x43	175223000	24	18	SV8,5	200	CP





## SEMNALIZARE ŞI ILUMINAT INTERIOR

LĂMPI CU BAZĂ  
DIN PLASTIC (BAX)

	CEE	Nr. ref.	V	W	Bază	Bucăţi/PU	Ambalaj
		170223000	24	1,2	EBS-R4 yellow	200	CP
		170383000	24	1,2	Bax 8,3d grey	200	CP
		170393000	24	1,2	Bax 8,5d grey	200	CP
		170673000	24	1,8	Bax 8,4d blue	200	CP
		170763000	24	1,2	Bax 8,5d brown	200	CP
		170813000	24	1,4	REF29 white	200	CP
		170823000	24	1,4	Bax 8,4d light green	200	CP
		171023000	24	1,2	EBS-R6 brown	200	CP
		171033000	24	1,2	EBS-R white 1,25 mm FR	200	CP
		170723000	24	1,2	EBS-R white frosted	200	CP







	CEE	Nr. ref.	V	W	Bază	Bucăţi/PU	Ambalaj
	P21W HD	176443000	24	21	BA15s	200	CP
	PY21W HD	176493000	24	21	BAU15s	200	CP
	T4W HD	171433000	24	4	BA9s	200	CP
	R5W HD	171863000	24	5	BA15s	200	CP
	R10W HD	173283000	24	10	BA15s	200	CP

## SETURI DE REZERVĂ

Seturile de rezervă sunt recomandate în cele mai multe țări și sunt obligatorii în Franța. NARVA a conceput seturi de rezervă astfel încât șoferii să poată înlocui lămpile arse rapid și ușor.

Descriere	Nr. ref.	Conținut	W	Bază	Nr. bucăți
 Set de rezervă H4	986143010	H4	75/70	P43t	2
		P21W	21	BA15s	6
		R10W	10	BA15s	2
		C10W	10	SV8,5	2
		W5W	5	W2,1x9,5d	2
		Flat fuse			8
		Cantitate ambalaj			
 Set de rezervă H7	986303010	H7	70	PX26d	2
		P21W	21	BA15s	4
		PY21W	21	BA15s	2
		R10W	10	BA15s	2
		C10W	10	SV8,5	2
		W5W	5	W2,1x9,5d	2
		Flat fuse			3
Cantitate ambalaj				20	

## INSTRUMENTE PENTRU VÂNZĂRI

Dozator de perete	
GOC (gol): 990287000	GOC (plin): 980173000
Livrat plin cu lămpi (vedeți structura de mai jos). carcasă metalică rezistentă Dimensiune compactă: 37 x 17,6 x 59,5 cm Poate fi încuiat	
Livrat cu	
<ul style="list-style-type: none"> <li>▪ 15x H1</li> <li>▪ 15x H3</li> <li>▪ 10x H4</li> <li>▪ 20x H7</li> <li>▪ 10x P21W</li> </ul>	<ul style="list-style-type: none"> <li>▪ 10x PY21W HD</li> <li>▪ 10x R5W</li> <li>▪ 10x R10W</li> <li>▪ 10x T4W</li> <li>▪ 10x W3W</li> </ul>
<ul style="list-style-type: none"> <li>▪ 10x W5W</li> <li>▪ 10x W12W</li> <li>▪ 10x C5W</li> </ul>	

# VEHICULE PE DOUA ROȚI

## LĂMPI DE 12V



NARVA oferă iluminare pentru motocicletă pentru condițiile de iluminare solicitante moderne. Lămpile noastre pentru motocicletă oferă vizibilitatea și siguranța de care au nevoie motocicliștii.

## DE CARE DINTRE TIPURILE DE LĂMPI PENTRU VEHICULE PE DOUĂ ROȚI AVEȚI NEVOIE?

- H1 48320
- H3 (6v) 48301
- H4 48222
- H7 48328
- H8 48076
- H9 48077
- H11 48078
- HB3 48005
- HB4 48006
- HS1 48220
- HS3 -
- HR2 PLAT -

- S2 49531
- S3 49014
- M5 P156-25-1 42007
- M5 P156-25-3 42017
- M5 BA20d 42027
- R2 49211

- W3W 17097
- W5W 17177
- W16W 17631
- T2W -
- T4W 17131

- T5W -
- H6W 68161
- R5W 17171
- R10W 17311

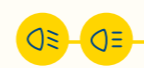

FAZĂ SCURTĂ  
FAZĂ LUNGĂ



SEMNALIZATOARE DIRECȚIE FAȚĂ

- W5W 17177
- W16W 17631
- W21W 17632
- WY21W 17629
- WY5W 17169
- H21W 68191

- R5W 17171
- R10W 17311
- RY10W 17317
- P21W 17635
- P21/5W 17916
- PY21W 17638



SEMNALIZATOARE POZIȚIE SPATE

- R5W 17171
- R10W 17311
- T4W 17131
- H6W 68161
- W3W 17097

- W5W 17177
- W21/5W 17919
- P21W 17635
- P21/5W 17916

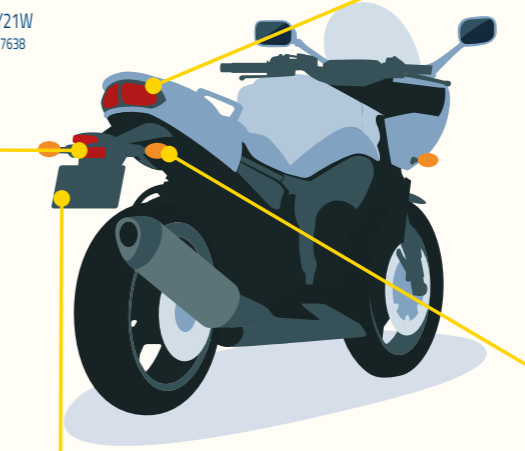
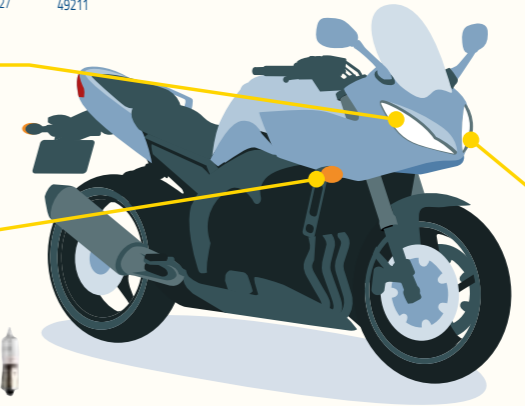

SEMNALIZATOARE POZIȚIE

SEMNALIZATOARE FRÂNARE

- P21W 17635
- P21/5W 17916
- R10W 17311

- RY10W 17317
- W16W 17631
- C5W 17125



PLĂCUȚĂ ÎNMATRICILARE

- R5W 17171
- R10W 17311
- T4W 17131
- W3W 17097
- W5W 17177
- H6W 68161
- C5W 17125

SEMNALIZATOARE DIRECȚIE SPATE

- W16W 17631
- W21W 17632
- WY21W 17629
- R5W 17171
- R10W 17311

- RY10W 17317
- PY21W 17638
- T3W -
- H6W 68161



	CEE HS1	Nr. ref. 482203000	V 12	W 35/35	Bază PX43t	Bucăți/PU 100	Ambalaj C1
	CEE H3	Nr. ref. 483013000	V 6	W 55	Bază PK22s	Bucăți/PU 100	Ambalaj C1
	CEE H4 Rallye	Nr. ref. 482223000	V 12	W 35/35	Bază P43t-38	Bucăți/PU 100	Ambalaj C1
	CEE S3	Nr. ref. 490143000 490043000	V 12 6	W 15 15	Bază P26s P26s	Bucăți/PU 200 200	Ambalaj CP CP
	CEE (M5) P15d-25-1	Nr. ref. 420073000 420053000 420013000	V 12 12 12	W 35/35 25/25 18/18	Bază P15d-25-1 P15d-25-1 P15d-25-1	Bucăți/PU 100 100 100	Ambalaj C1 C1 C1
	CEE (M5) P15d-25-3	Nr. ref. 420173000 420153000	V 12 12	W 35/35 25/25	Bază P15d-25-3 P15d-25-3	Bucăți/PU 100 100	Ambalaj C1 C1
	CEE (M5) BA20d	Nr. ref. 420273000 420253000	V 12 12	W 35/35 25/25	Bază BA20d BA20d	Bucăți/PU 100 100	Ambalaj C1 C1

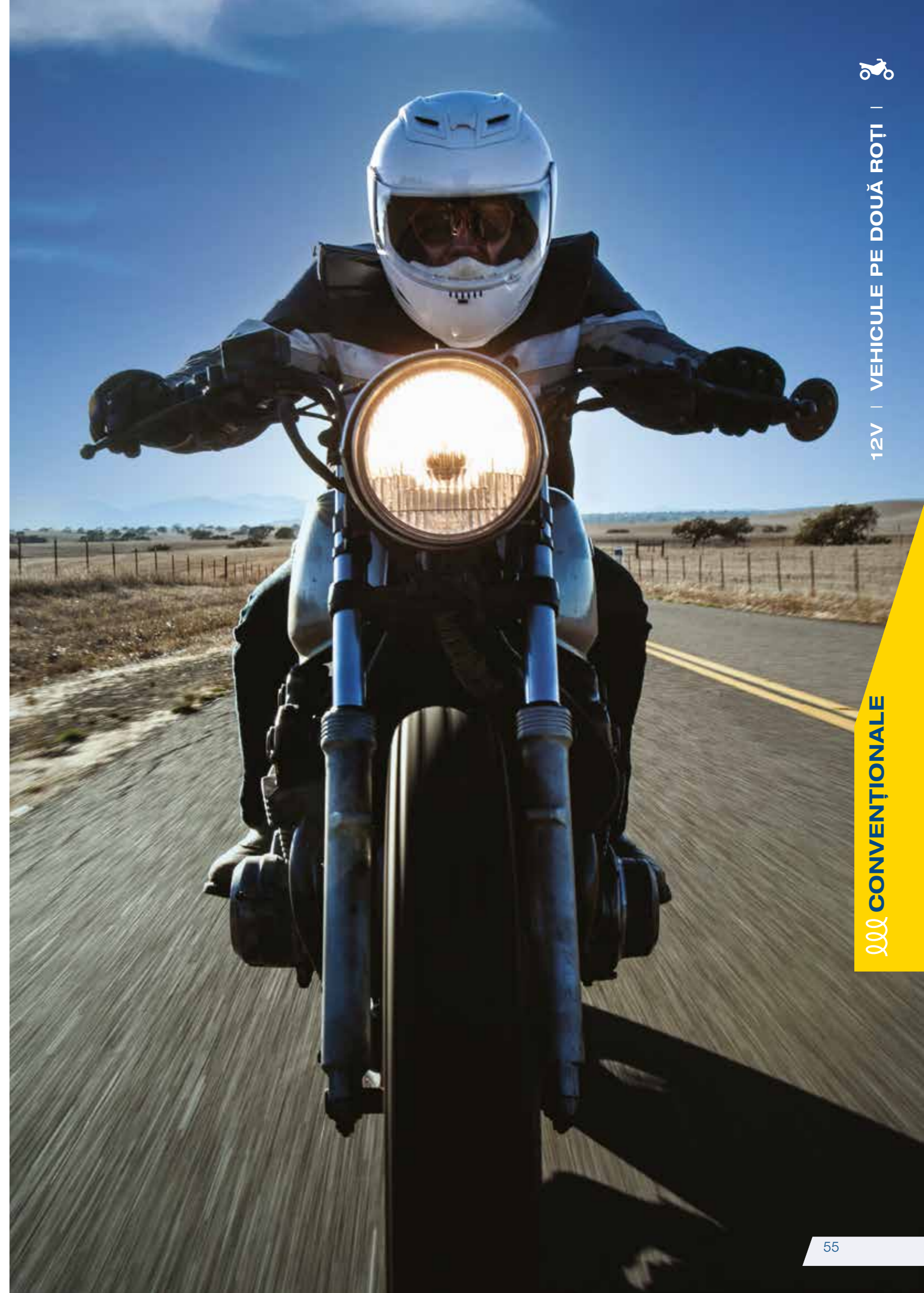





# SOLUȚII CU XENON



VEHICULE ȘI CAMIOANE

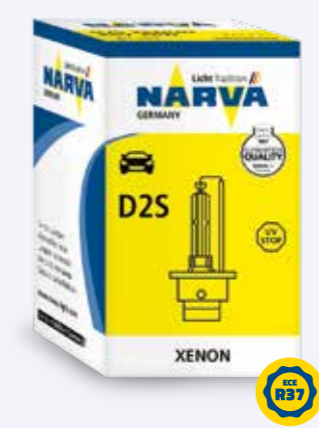

- D1S
- D1R
- D2S
- D2R
- D3S
- D3R
- D4S

# XENON LĂMPI



## DE CE TIP DE LAMPĂ AVEȚI NEVOIE?



FAZĂ SCURTĂ  
FAZĂ LUNGĂ



D1S



D1R



D2S



D2R









D3S



D4S

Gama cu xenon **NARVA** produce o lumină albă strălucitoare, cu o rază precisă, asigurând vizibilitate superioară pentru siguranță superioară.

Tehnologia cu xenon **NARVA** înseamnă durată lungă de viață și lumină puternică pe drum. Având o sticlă de cuarț specială pentru blocare UV, această soluție de iluminare oferă o vizibilitate bună și siguranță maximă, permițând șoferilor să vadă mai departe.

	CEE D1S	Nr. ref. 840103000	V 85	W 35	Bază PK32d-2	Bucăți/PU 2	Ambalaj C1
	CEE D1R	Nr. ref. 840113000	V 85	W 35	Bază PK32d-3	Bucăți/PU 2	Ambalaj C1
	CEE D2S	Nr. ref. 840023000	V 85	W 35	Bază P32d-2	Bucăți/PU 2	Ambalaj C1
	CEE D2R	Nr. ref. 840063000	V 85	W 35	Bază P32d-3	Bucăți/PU 2	Ambalaj C1
	CEE D3S	Nr. ref. 840323000	V 42	W 35	Bază PK32d-5	Bucăți/PU 2	Ambalaj C1
	CEE D4S	Nr. ref. 840423000	V 42	W 35	Bază P32d-5	Bucăți/PU 2	Ambalaj C1

## PREZENTAREA SISTEMELOR DE ILUMINARE CU XENON

### Principalele beneficii

- / Proiectare strălucitoare și puternică a luminii pe drum
- / Culoare și intensitate a luminii apropiate de lumina zilei
- / Durată foarte mare de viață
- / Consum de putere scăzut



**Xenon HID**  
Lampă cu descărcare de mare densitate

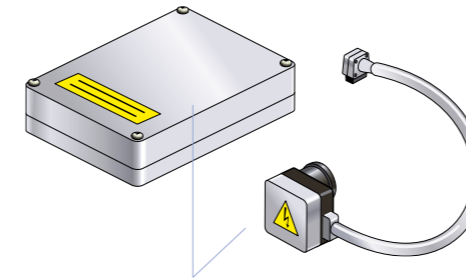

Balast electronic și starter de înaltă tensiune



Sistem optic complex cu control automat al nivelului și sistem de spălare puternică



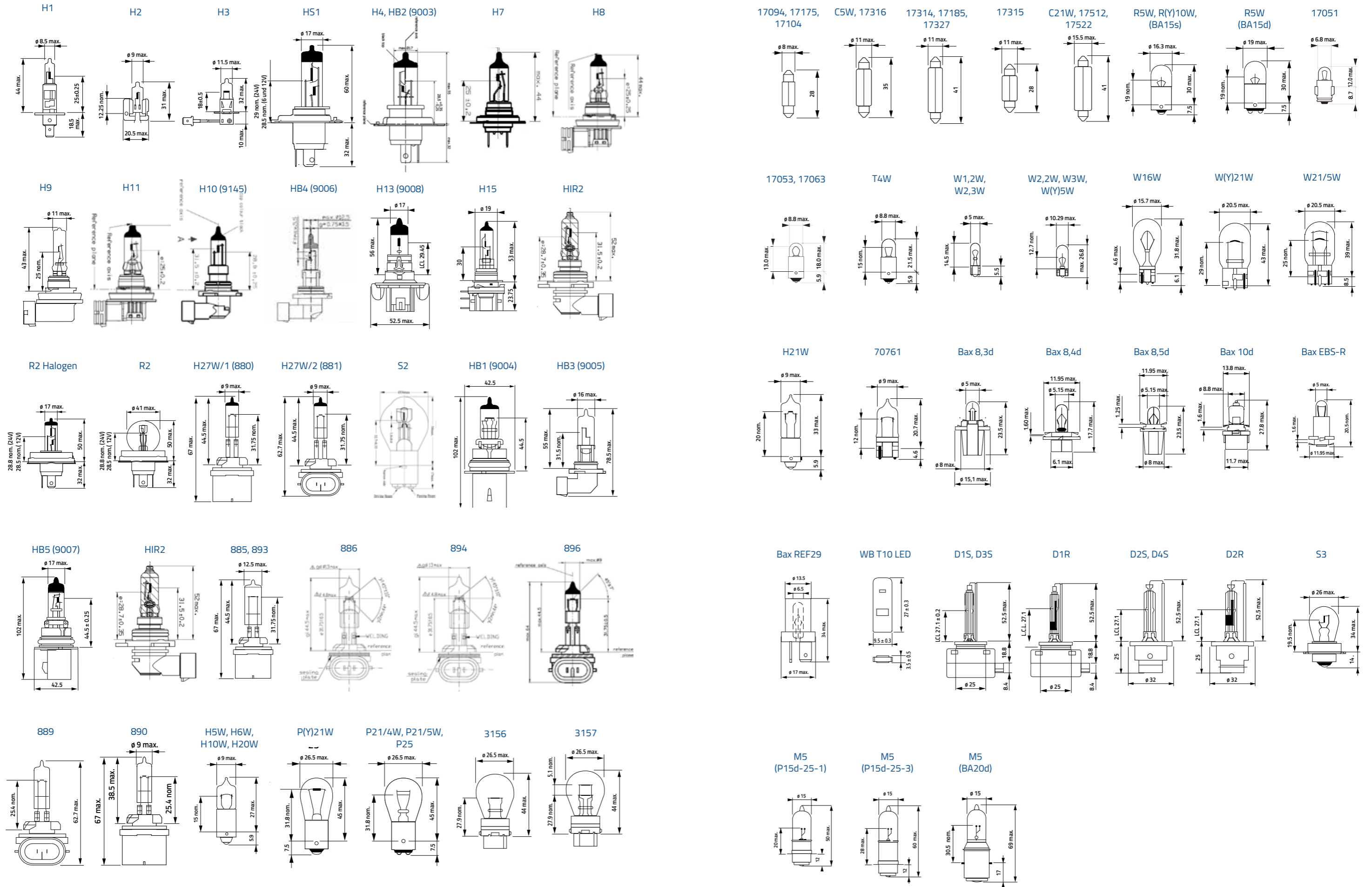

BAZĂ (IEC 60061-1)

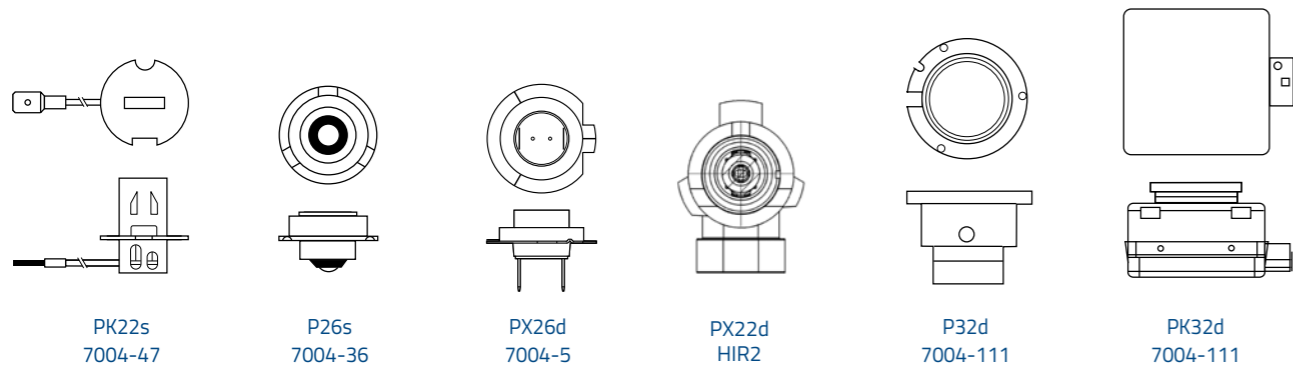
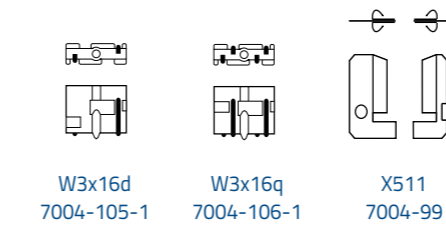
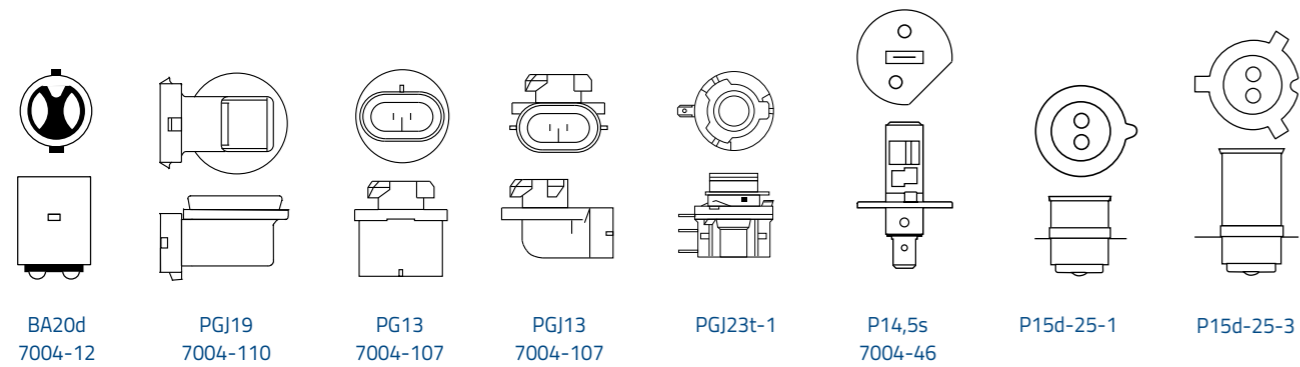
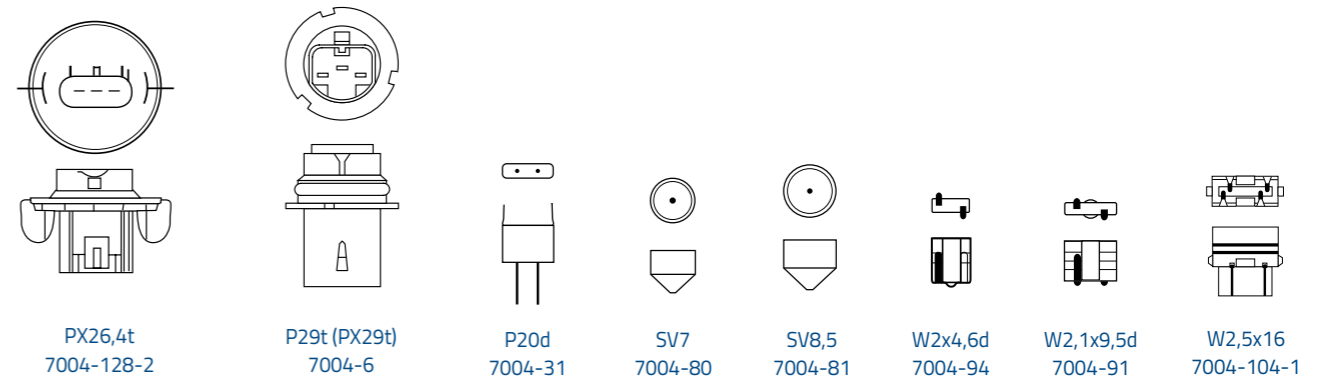
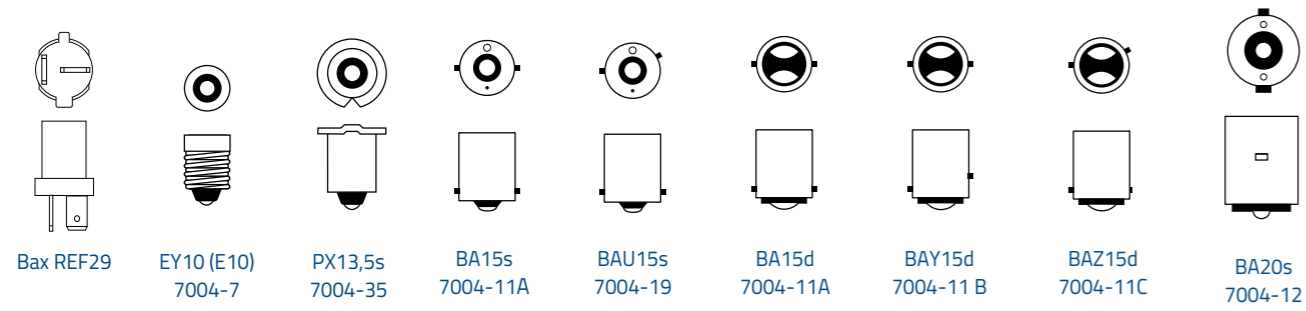
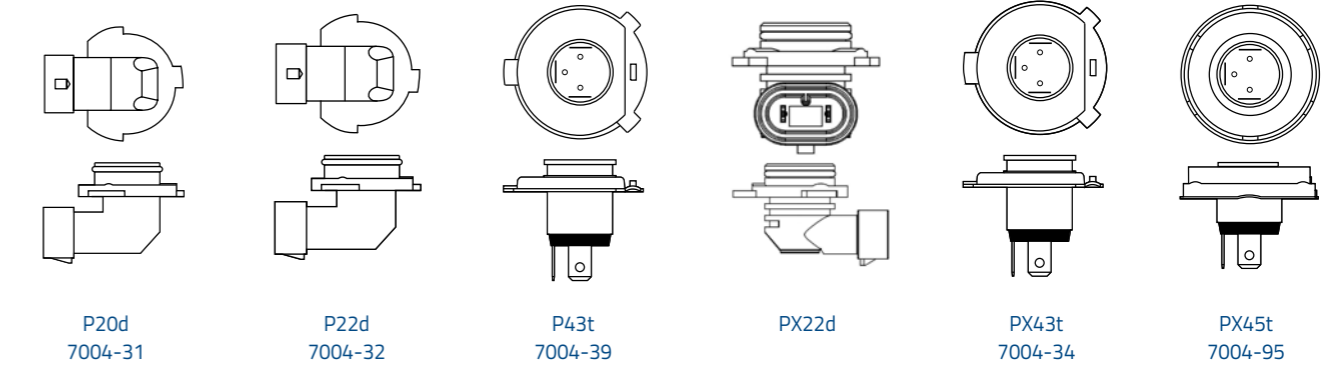
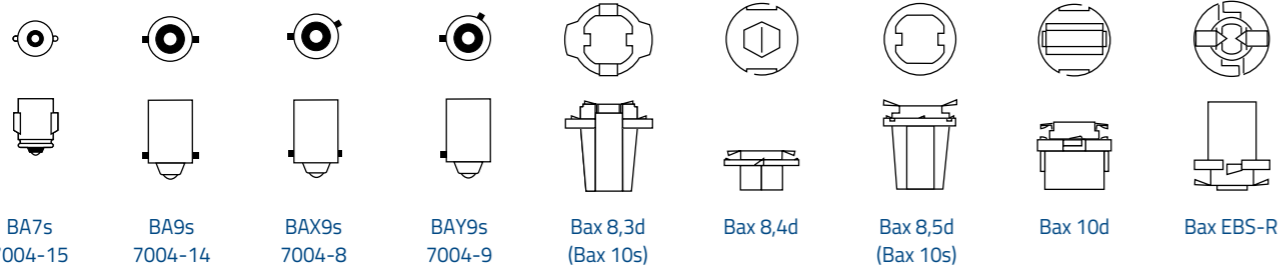



Pachet comercial



Blisters



Seturi de rezervă

## AMBALAJ

### Înțelegerea codului de comandă NARVA



Cod tip ambalaj

Cod de comandă

### Ambalaj special NARVA

Ambalajul nostru este folosit atât pentru pachetele speciale duble cât și pentru seturile de rezervă. Informațiile despre produs sunt prezentate simplu și clar pe partea din spate, pentru a ajuta clienții să ia o decizie informată.

Designul atractiv al ambalajului oferă o imagine clară a produselor din interior, iar structura robustă protejează conținutul în timpul transportului, precum și în magazin.

- / Economic
- / Reduce deșeurile
- / Informații clare
- / Structură robustă



C1/CP  
Pachet comercial  
**3000**



S2/SM  
Pachet dublu special  
**2100**



B1/B2  
Blister singular / Blister dublu  
**4000**



x2  
Pachet special dublu  
pentru LED-uri  
**3000**

### Abrevieri pentru denumirile gamelor

<b>HD</b>	Heavy Duty Rezistă la toate vibrațiile	<b>RPB+</b>	Range Power Blue+ Cu până la 50% vedere mai bună, alb elegant
<b>LL</b>	Long Life Perioadă de funcționare dublă	<b>RPW</b>	Range Power White* 4500 K Alb xenon
<b>RA</b>	Rallye* Foarte strălucitor	<b>RPE</b>	Range Performance LED** Până la 6500 K, lumină albă clară
<b>RP50+</b>	Range Power 50+ Cu până la 50% vedere mai bună		
<b>RP150</b>	Range Power 150 Cu până la 150% mai multă luminozitate		

\*Important Produsele care nu au logo de omologare CEE nu sunt omologate și nu pot fi vândute în Europa.



\*\*Este responsabilitatea dvs. să vă asigurați că utilizarea luminilor cu LED cu montare pe vechile instalații respectă cerințele legale aplicabile.



# **NARVA**

**D A S L I C H T**

**Lumileds Germany GmbH**

Philipsstraße 8  
52068 Aachen  
Germania

Tel. +49 (0)3741 746 8181  
E-mail: [info@narva-light.com](mailto:info@narva-light.com)  
[www.narva-light.com](http://www.narva-light.com)

© 2023 Lumileds Holding B.V.  
RO-RO • 2023

Member of **NARVA e.V. Germany** ///